

# Push-On Tool User Manual



## Contents



Push-On Tool

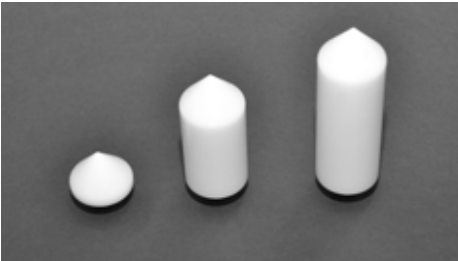

Mandrels (3 short, 2 medium, 2 long)



Lubricant

---

## Push-On Tool Components

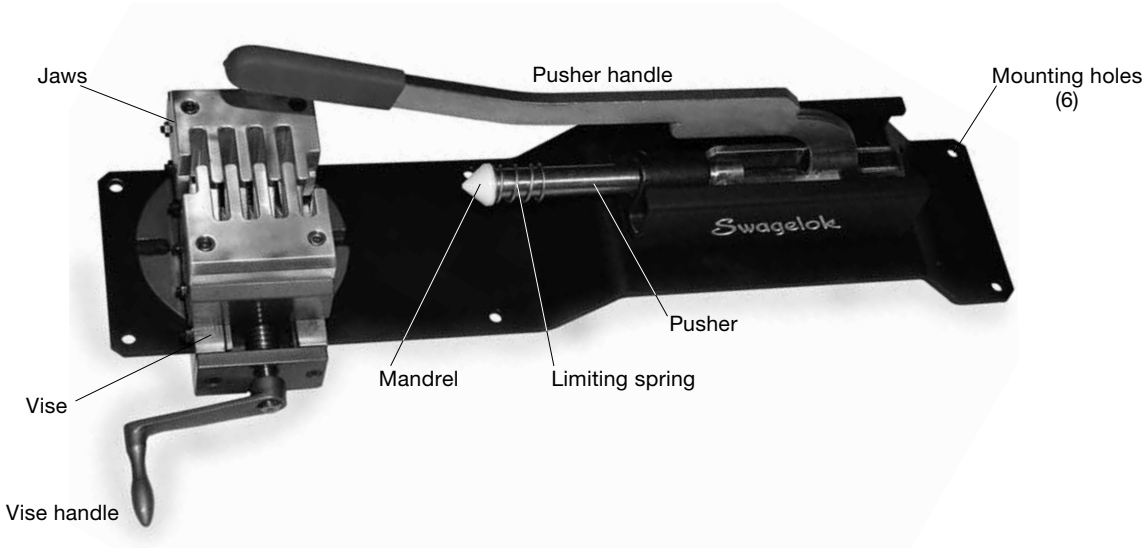

## Preparation

1. Use six 3/8 in. bolts or a clamp to attach the tool to a workbench. (Bolts and clamp are not provided).



2. Line up the flats of the vise handle to the tool and push the handle on until it stops. Thread the set screw into the handle and tighten with a 1/8 in. hex key.

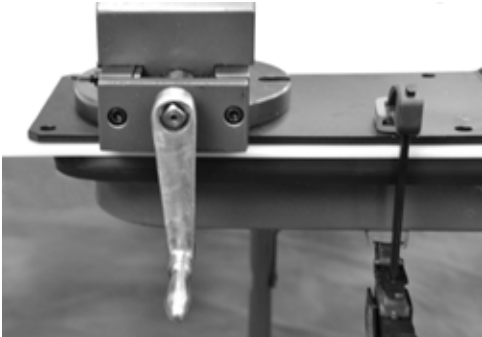

3. Inspect the tool and jaws for wear. Replace the jaws if excessive wear is observed. (The jaws will be rough to the touch.)



4. Lubricate the tool shaft in the locations shown with the provided lubricant prior to initial use and approximately every 500 assemblies or once per week. Cycle the handle several times after applying the lubricant.

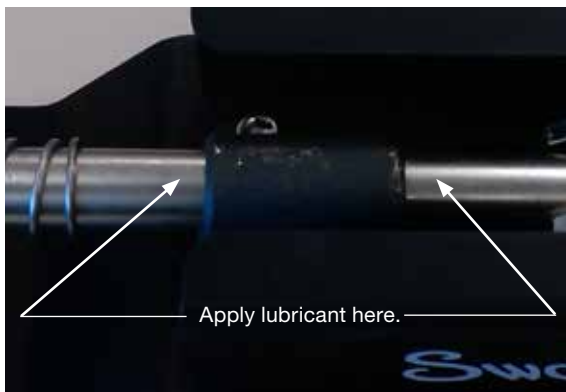

5. Select the appropriate mandrel according to the table.

Hose Type	Nominal Hose Size, in.	Recommended Mandrel Size
Rubber	1/4, 3/8, 1/2	Long
	3/4	Medium
	1	Short
Nylon and Polyethylene	1/4, 3/8	Long
	1/2	Medium
	3/4, 1	Short

6. For assemblies using tube fitting end connections (-SL and -SM designators), verify that the nut and ferrules are installed prior to pushing the end connection onto the hose. Install if necessary.



*Nuts and Ferrules  
Not Installed*



*Nuts and Ferrules  
Installed*

7. Place the pusher handle in the down position.
8. Verify that the limiting spring is installed.
9. Thread the selected mandrel into the end of the pusher fingertight.

Note: The short mandrel is installed at the factory. Remove it from the pusher if a different size is needed.

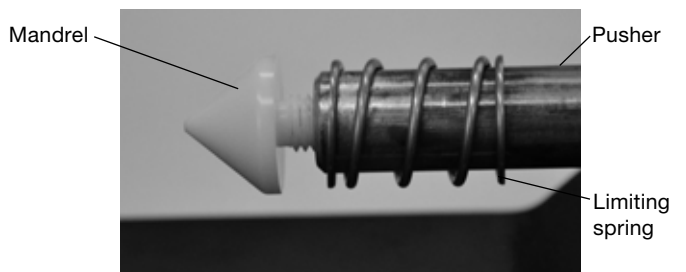

10. Ensure that the hose end is properly cut using a hose cutting tool (must be ordered separately).

Cutting tool ordering numbers:

- MS-HC-SC-1A for nylon, polyethylene, or rubber hose up to 1 in. nominal size.

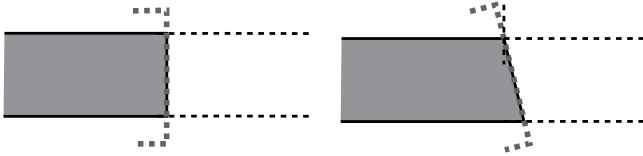

Proper cut

Improper cut

11. Nylon and Polyethylene hose:

Place one end of the hose into the appropriate hole on a depth insertion gauge (must be ordered separately), until it bottoms out.

Gauge ordering numbers:

- MS-IGB-1 for 1/4, 3/8, and 1/2 in. hose.
- MS-IGB-2 for 3/4 and 1 in. hose.



Mark the hose with a sharp grease pencil as close to the gauge as possible.

Note: The bottom of the mark should line up with the top of the insertion gauge.

Proper mark position

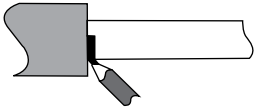

Improper mark position

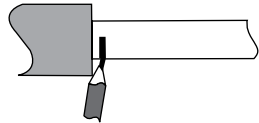

### Insertion of End Connection onto Hose

1. Raise the pusher handle approximately 90°.

Note: The handle should not be moved to the fully back position. This will cause the tool to wear prematurely.



2. Turn the vise handle counterclockwise to open the jaws until the hose can pass through freely.

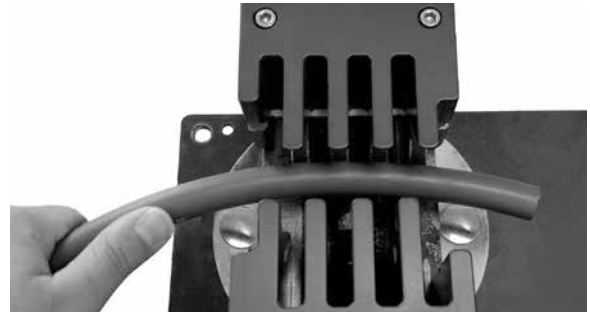

Note: The handle may have a higher initial actuation torque if it is new or has not been turned for a period of time.

3. Use the end connection as a gauge and slip the hose through the jaws until the hose sticks out the length of the barbs or shell on the end connection plus approximately an additional 1/2 inch (12.7 mm).

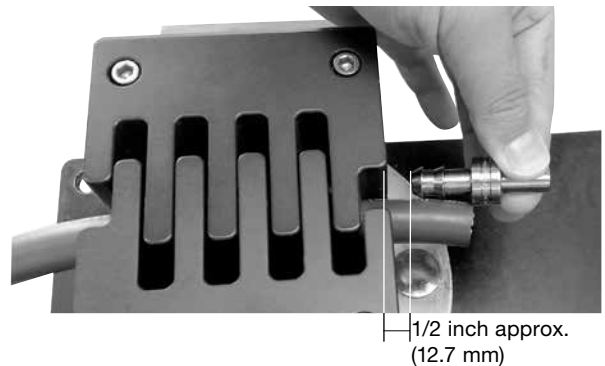

- Turn the vise handle clockwise to close the vise until the jaws just hold the hose in place. Turn the handle an additional 1/4 to 1/2 turn to secure the hose.

Note: If the hose still moves, repeat steps 3 and 4, tightening the vise handle until the hose is secure.

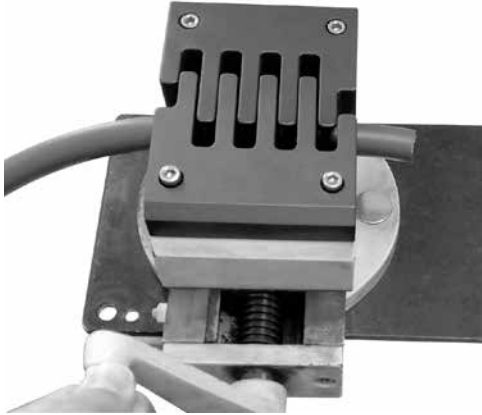

- Insert the first barb of the end connection into the hose.

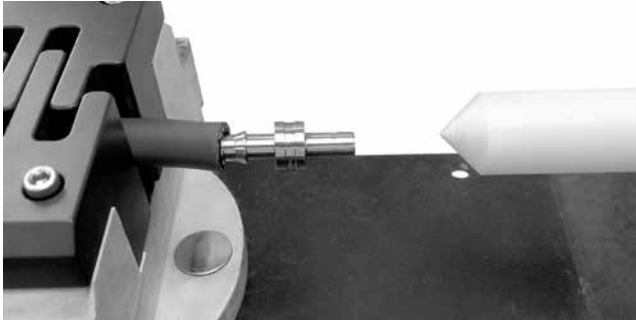

- Lower the pusher handle until the mandrel meets the end connection.

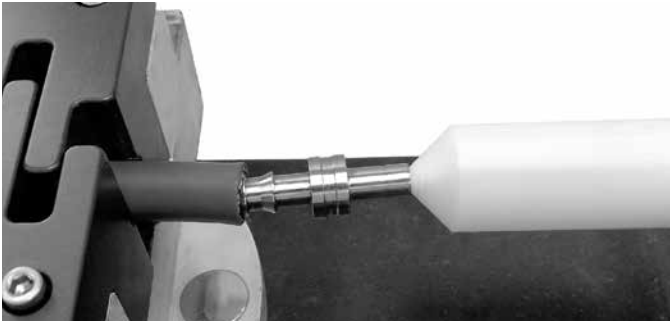

- Hold the hose in line with the end connection and lower the pusher handle to push the end connection into the hose until the end connection is inserted properly according to the table below.



**CAUTION**

There is a potential pinch point between the end of the hose and the divider tab.

Hose Type	Insertion Criteria
Rubber	Hose seats flush with the divider tab
Nylon and Polyethylene	Bottom of the insertion mark lines up with the edge of the end connection.

If the hose is not properly inserted, open the jaws, and repeat *Insertion of End Connection onto Hose* steps 3, 4, 6, and 7.

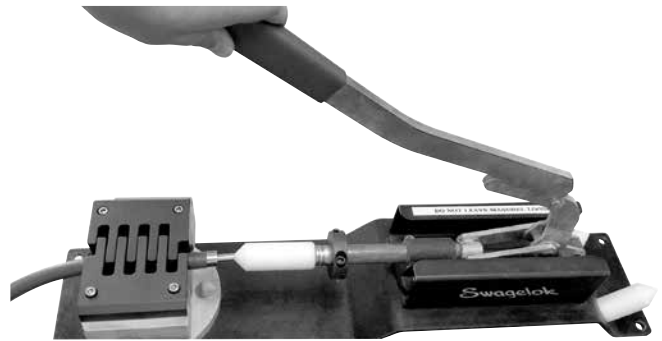

- Raise the pusher handle and open the jaws to remove the hose.

Note: The recommended method is to fully open the jaws and unload from the top. Larger hose sizes will have to be pulled through the jaws to be removed.

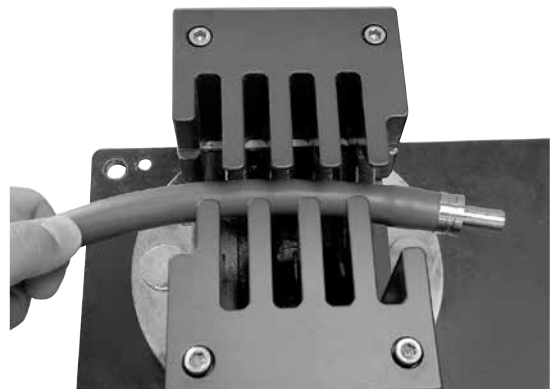

Replaceable Component	Ordering Number
Push-On tool	MS-SPOT
Mandrel kit	MS-SPOT-MKIT
Jaws	MS-SPOT-JAW-KIT
Lubricant	MS-TP-LUBE